

#5 Twin Crane

(c) 3/98 by Julius Kusserow

page 1/1

This "Twin Crane" is based on a "Twin Crane" model I saw 9 month ago. Possible it is a recreation of a design from a person unknown to me or it is a different design. It was the first advanced origami model I have ever seen and the base for my new passion: Origami. Thanks to Martin Hunger who taught me my first model. Thanks to Nayumi Kitamura who show the model of the "Twin Crane" to me.

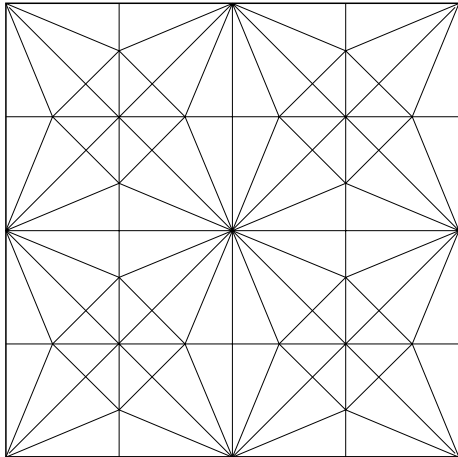

<- (0) The unfolded model without the creases from narrowing tails and necks and making the heads (step 22).

Square shape paper of length X gives
ca. 0.5 X width
ca. 0.3 X depth and
ca. 0.3 X height model.

(1) -> Fold and unfold both diagonals as valleys. White side up.

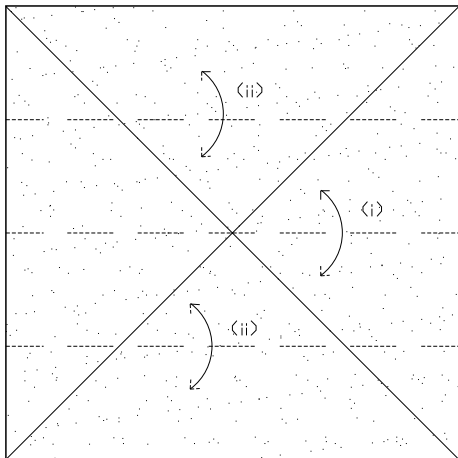
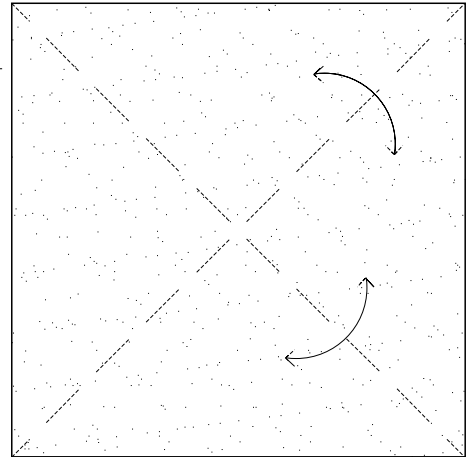

<- (2) (I) Fold and unfold centre crease. (II) Fold to centre crease.

(3) -> as in (2) turn around.

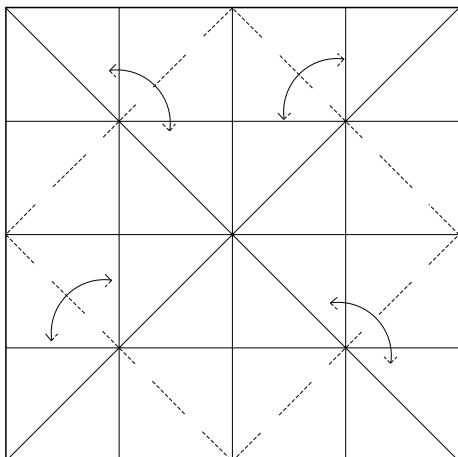
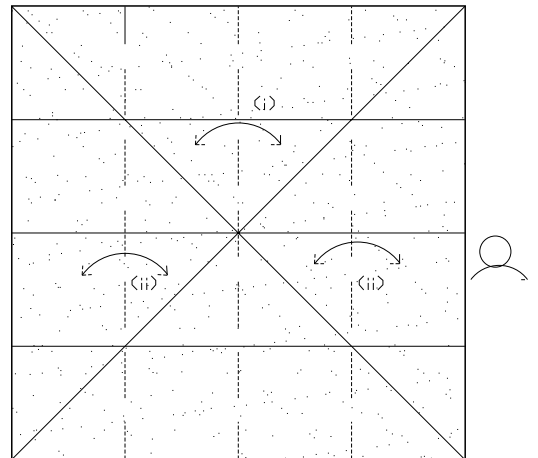

<- (4) Blintz and unfold. Turn around.

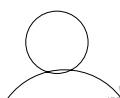

(5) -> Fold a "Preliminary Base".

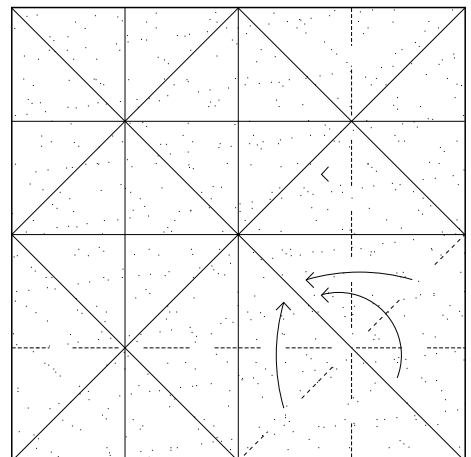

Twin Crane

(c) 3/98 by Julius Kusserow

page 2/3

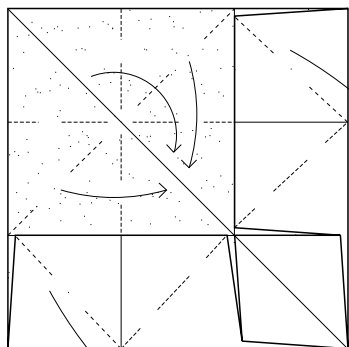

<-(6) Fold another "Preliminary Base". Fold two rabbit ears. Circle 45 degree right.

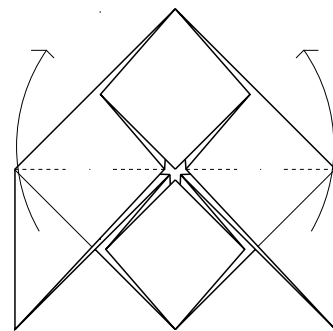

<(7)-> Fold as mountain. Let swing rabbit ears to top.

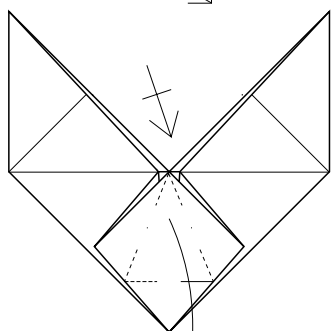

<-(8) Petalfold. Repeat behind.

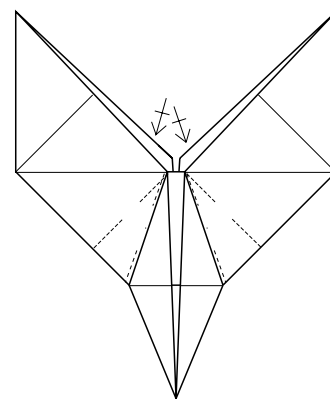

<(9)-> inside reverse and outside reverse fold to create the rest of the bird base. Fold all 4 reverse folds simultaneous.

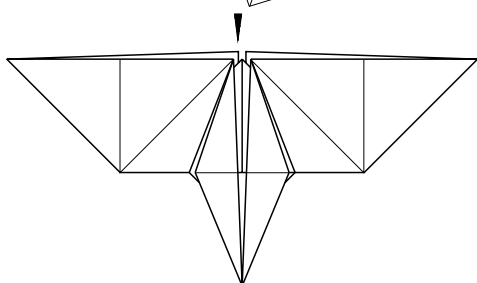

<-(10) Unsink middle. You can also do (9) and (10) in on step. Try to create the other half of the bird base. Sometimes this is the easier way.

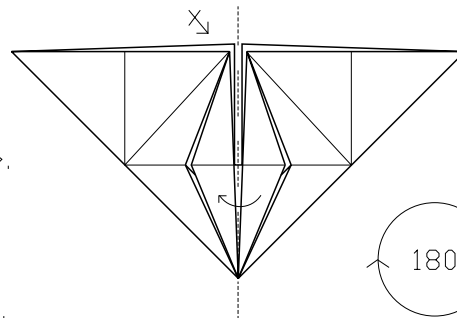

<(11)-> Fold first and second flap to the left. Repeat on other side. Circle 180 degree.

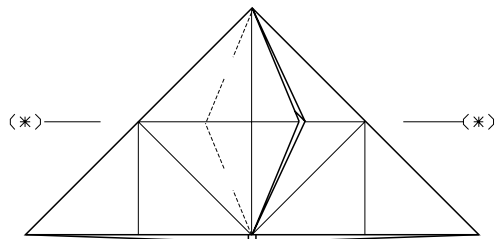
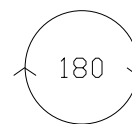

<-(12) Precrease up to (*) crease.

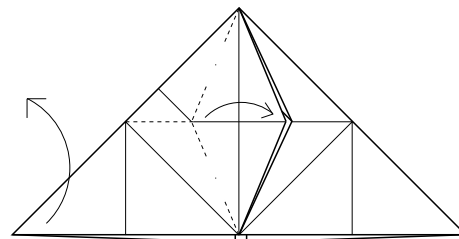

<(13)-> Squash. Fold flap to the left.

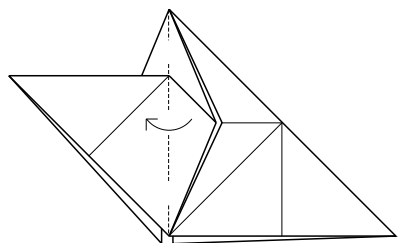

<-(14) Fold first flap to the left.

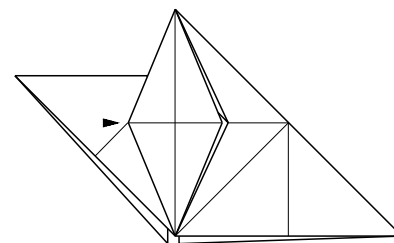

<(15)-> Close sink flap from step 14.

Twin Crane

(c) 3/98 by Julius Kusserow

page 3/3

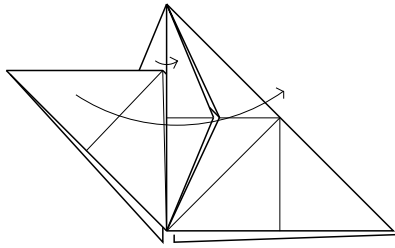

<- (16) Fold large flap and first small flap to the right.

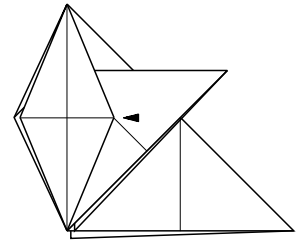

(17)-> Close sink.

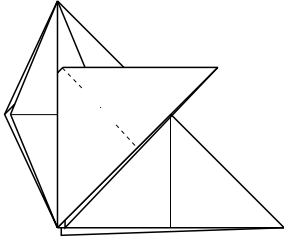

(18) Squashfold.

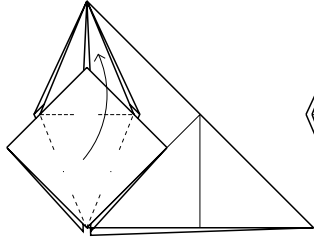

(19)-> Petalfold.

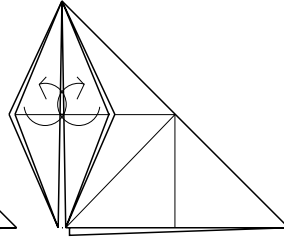

<- (20) Left and right: put flap in the pocket from close sinks in steps 15/17.

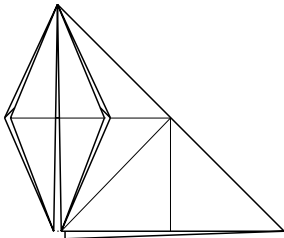

(21) Repeat steps 11-20 (22) Fold two flaps on other side.

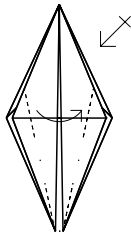

(22) Fold two flaps to the right. Repeat behind.

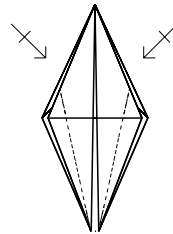

<- (23) Narrow neck and to with valleys (first step). Repeat behind.

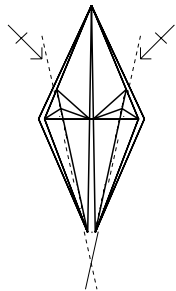

<- (24) Narrowing neck and tail, step two with mountains. Repeat behind.

(25)-> Inside reverse necks and tails. Inside reverse heads. Pull on wings to give the body volumuna.

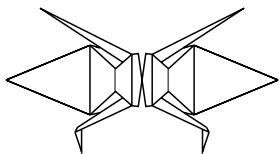
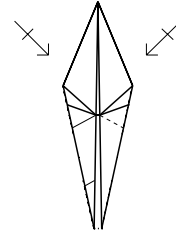

Finished "Twin Crane"

<- Top View

-> Bottom View

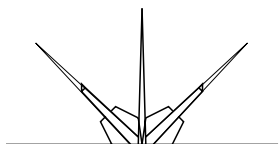
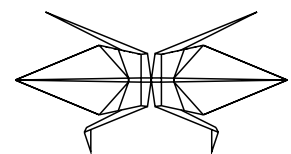

<- Front View

-> Side View

